

Article number: 12503000060100
Description: KLEE-coil 503 000 060.100
M6 Hardened, zinc-pl./chr. yellow

Measures

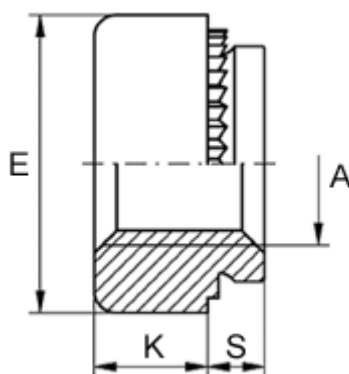

Female thread A	= M6
Height K	= 4.0
Max recess height	= 3.0
Min distance to edge	= 5.0
Outer diameter E	= 11.0
Plate thickness	= from 3.3
Recommended bore diameter +0.05	= 9.00